



CENTURION
THE AUTOMATIC CHOICE
www.centsys.co.za

D2
TurboTM

D2 Turbo domestic sliding gate operator

User guide



SLIDING GATE OPERATORS



SWING GATE OPERATORS



GARAGE DOOR OPERATORS



REMOTE CONTROLS



INTERCOMS



SAFETY BEAMS



KEYPADS



Established 1986

Company overview

Centurion Systems has been manufacturing automatic gate systems since 1986, and is committed to providing reliable, cost effective solutions in the field of gate and access automation.

We offer a diverse range of products including gate motors, GSM-based products, garage door motors, remote controls, keypads, traffic barriers, proximity access control and intercom systems.

Our products are developed by an in-house team of talented engineers that are constantly researching new and innovative products to add to our range and upgrade existing models.

We are accredited with the world class quality assurance system, ISO 9001-2008, to ensure that our products are manufactured to the highest level of quality with a 100% test to specification.

Through a team of dedicated technicians and sales personnel, together with a fully fledged in-house training facility, we are committed to providing unmatched service and support for our products.

The equipment is installed worldwide and is available through a network of competent distributors and installers.

Further information is available on our website www.centsys.co.za.



Centurion Systems (Pty) Ltd. reserves the right to make changes to the products described in this document without notice and without obligation of Centurion Systems (Pty) Ltd. to notify any persons of any such revisions or changes. Additionally, Centurion Systems (Pty) Ltd. makes no representations or warranties with respect to this document.

No part of this document may be copied, stored in a retrieval system or transmitted in any form or by any means electronic, mechanical, optical or photographic, without the express prior written consent of Centurion Systems (Pty) Ltd.

Contents



IMPORTANT SAFETY FEATURES

	IMPORTANT SAFETY FEATURES	page 1
Introduction		page 2
D2 Turbo overview		page 2
1. Identification of parts		page 3
2. Manual Override		page 4
2.1. Disengage the gearbox/drive		page 4
2.2. Re-engage the gearbox/drive		page 4
3. Features and functions		page 5
Introduction		page 5
3.1. Gate Operation		page 5
3.1.1. Full Gate Opening		page 5
3.1.2. Modes of Operation		page 5
3.1.2.1. Standard Mode		page 5
3.1.2.2. Open Only Mode		page 6
3.1.2.3. Reversing Mode		page 6
3.1.3. Automatic Closing (Autoclose Mode)		page 7
3.1.3.1. Autoclose Override		page 7
3.1.4. Pedestrian Opening		page 8
3.1.5. PIRAC Mode (Beam Autoclose) - optional		page 9
3.1.6. Holiday Lockout Mode		page 10
3.1.7. Positive Close Mode		page 10
3.1.8. Speed Profiles		page 11
3.1.9. Anti-crushing Sensitivity		page 11
3.1.9.1. Collision Count		page 11
3.1.10. Safety beams (optional, but recommended feature)		page 11
3.1.10.1. Closing Safety Beams		page 12
3.1.10.2. Opening Safety Beams		page 12
3.1.11. Courtesy (Pillar) Light Timer (optional feature)		page 13
3.1.11.1. Courtesy (Pillar) Light act as Warning Light		page 13
3.1.11.1A. Pre-flashing Modes		page 13
3.1.12. External Gate Status Indication LED		page 14
3.1.13. Battery Low Protection		page 14

4.	Customising the features and functions	page 15
	Examples:	
A.	Setting up the gate Limits	page 17
B.	Remote control administration	page 18
C.	Adding NOVA remote controls (Keeloq™ encryption)	page 19
D.	Deleting specific remote controls	page 20
E.	Deleting ALL remote controls	page 21
F.	Setting the Autoclose feature	page 22
G.	Setting the Mode of Operation	page 24
H.	Setting PIRAC Mode	page 26
I.	Setting the Pre-flashing Modes	page 27
J.	Setting the Operating Profiles	page 28
K.	Verifying your setup	page 30
5.	Additional features	page 31
5.1.	Battery saver	page 31
5.2.	Solar power supply	page 31
6.	Basic Maintenance	page 32
7.	Servicing your D2 Turbo	page 32
8.	Diagnostics	page 33
9.	Specifications	page 34
10.	24 Month product warranty	page 35
11.	Optional extras	page 37

Icons used in this user guide



This icon indicates tips and other information that could be useful during the installation.



This icon denotes variations and other aspects that should be considered during installation.



This icon indicates warning, caution or attention! Please take special note of critical aspects that **MUST** be adhered to in order to prevent injury.

IMPORTANT Safety instructions



Even if you have owned and used an automated gate before, we suggest that you read through the safety instructions below very carefully. Although years of thought have been put into every CENTURION product – and your safety is our top priority – accidents do happen. So, please make sure that you fully understand the following safety requirements before using your automated gate.

Before you attempt to use your new gate operator for the first time, you should know:

- How to operate the Manual Release thumbwheel
- How the Obstruction Detection System and all other safety features work
- All the safety considerations that come with operating an automated gate – and the importance of explaining these considerations to everyone who uses the operator

DOs and DON'Ts

1. Do not activate your gate opener unless you can see it. Make sure that no people, pets or any other obstructions are in your gate's area of travel.
2. NO ONE MAY CROSS THE PATH OF A MOVING GATE. Our advanced obstruction detection technology is designed to stop your gate in its tracks should a child or pet be in the way. However this is a reactive system and should never supersede proactive measures of preventing people, pets or vehicles from moving into the path of a moving gate.
3. Check if the obstruction detection system and safety devices for correct operation are in working order once a month.
4. Children should be supervised to ensure that they do not play with the appliance.
5. This appliance is not intended for use by persons (including children) with reduced physical, sensory or mental capabilities, or lack of experience and knowledge, unless they have been given supervision or instruction concerning use of the appliance by a person responsible for their safety.
6. Always be mindful of where your limbs are when dealing with moving parts – you don't want your fingers to be pinched (or worse).
7. Keep your gate controls (remote controls) in a safe place. You don't want anyone getting in uninvited.
8. Look after your gate and it will look after you. Ensure that all working areas are debris-free and that your automated system is well-maintained and your CENTURION operator should last you a very long time.
9. Ensure that any technician that works on your operator has been trained by CENTURION.
10. This product was designed and built strictly for the use indicated in this documentation. Any other use, not expressly indicated here, could compromise the good condition/operation of the product and/or be a source of danger.
11. Centurion Systems does not accept any liability caused by improper use of the product, or for use other than that for which the automated system was intended.

Safety
FIRST

Introduction

This User Guide contains all the information you need to configure and operate your new D2 Turbo Sliding Gate Operator.

From safety instructions to basic principles of operation and an in-depth description of your CENTURION product's many features and functions, by the time you have finished reading this guide you will have learnt how to make the most out of your gate operator.

Even Basic Maintenance is covered but, in the unlikely event that your CENTURION product malfunctions, rather leave it to the professionals and contact your installer or nearest Centurion Systems branch (contact details listed on the back page) for prompt assistance.

D2 Turbo overview

The D2 Turbo has various useful features and functions, all easily accessible from a user-friendly dial-based setup system. Multiple Modes of Operation, Speed Profiles, an onboard multichannel receiver – you name it, the D2 Turbo's got it.

The integral 12V 5Ah battery (charged by an internal 220V charger) comes with full battery backup and advanced lightning protection so you can always get in – even when the power is out. For increased power capacity you can install a larger, 7Ah battery (your D2 Turbo was designed to cater for this), or you can even use a solar panel to power it. (see the section on Solar Panels, for more details about solar charging)

The D2 Turbo is designed to open and close domestic sliding gates weighing up to 250kg. It must not be installed or used to automate the entrances of townhouses complexes, housing estates, commercial or industrial properties.

The gearbox, moulded from a high-tech engineering polymer not only looks good, but is corrosion-free and guarantees that even if you live at the coast, your D2 Turbo will just keep on going.

For your security, the internal gearset has a self-locking action so forced entry is not an option for would-be burglars.

An optional Theft-resistant Cage and Theft-resistant Locking Nut makes intruders' lives even more difficult.

For your safety, our revolutionary limit switch mechanism monitors the speed and location of your gate for accurate position control and sensitive anti-crushing protection.

1. Identification of parts

Refer to the drawings below, for how to identify your D2 Turbo operator and its parts.

1. Motor fuse
2. Motor enclosure unit
3. Camlock cover
4. Manual release thumbwheel
5. Foundation plate
6. Spare fuse
7. Function Dial
8. Status LED
9. Pushbutton
10. D2 Turbo controller
11. Settings Dial
12. 12V 7.2Ah or 5Ah battery
13. Battery strap
14. Pulley guard
15. Gate mounted origin marker
16. Origin marker bracket
17. D2 Turbo controller
18. 12V 7.2Ah or 5Ah battery
19. Motor housing
20. Pinion
21. Pinion guard

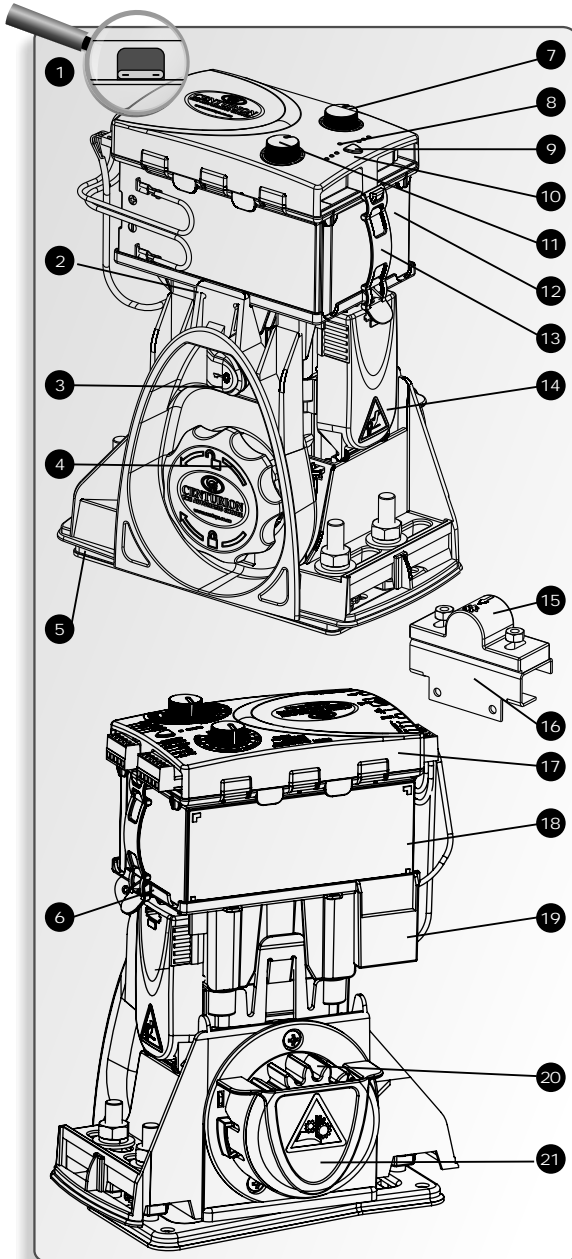

FIGURE 1

2. Manual Override

Manual Override

2.1. Disengaging the gearbox/drive

To manually override the operator you will need to: Open the camlock cover, insert the camlock key and rotate it 90° clockwise (the operator cover can also be removed at this stage if so desired).

This will allow for the rotation of the Manual Release thumbwheel.

By turning the Manual Release thumbwheel 90° counter-clockwise until it clicks, the motor pinion will be put into 'Manual Mode'.



FIGURE 2

2.2. Re-engaging gearbox/drive

To re-engage the drive mechanism of the operator, turn the Manual Release thumbwheel 90° clockwise until it clicks. Once you have re-engaged the drive mechanism don't forget to lock the camlock by inserting the key and rotating it 90° counter-clockwise – this will help prevent unauthorised tampering with the operator.

By locking the camlock, the Manual Release thumbwheel cannot be moved from 'locked' to 'unlocked' and vice versa.



FIGURE 3

3. Features and functions

Introduction

The D2 Turbo sliding gate operator's advanced functions are controlled by an intelligent micro-controller based electronic controller.



FIGURE 4

3.1. Gate operation

3.1.1. Full Gate Opening

The NOVA remote controls (with Keeloq™ encryption) supplied with the D2 Turbo are used to operate the gate.

However, most automatic gate installations are also fitted with an intercom, which provides for communication between the house or building and the gate. The handset is usually fitted with a gate pushbutton, which when pressed, sends a signal to the D2 Turbo controller to operate the gate.



FIGURE 5

3.1.2. Modes of Operation

To operate the gate to open fully, the D2 Turbo has three modes to choose from depending on the application. Only one mode can be selected at any given time.

- 3.1.2.1. Standard Mode

Standard Mode is the most commonly used mode for domestic applications as it allows full control of the gate. Press the remote control button for approximately one second to get the gate in motion. If the remote control button is pressed while the gate is

moving, the gate will stop. Press the remote control button again and the gate will go into reverse.

Autoclose (page 7) and PIRAC (Beam Autoclose) (page 9) can be used together with Standard Mode.

- 3.1.2.2. Open Only Mode

This mode is ideal for increased safety in multi-user single dwelling applications.

If you select Open Only Mode, your gate will open when you press the button of the remote control or the gate pushbutton on the intercom – but pressing the button again while the gate is opening will be ignored. It will not cause the gate to stop or to reverse. Only the internal Autoclose feature described on page 7 of this User Guide, which is automatically enabled, will close the gate if you have selected Open Only Mode.

If the button of the remote control or intercom gate release is pressed while the gate is closing, the gate will immediately reopen. The gate cannot be stopped in a midway position and will therefore always close. If the button is pressed while the gate is in the open position, the Autoclose timer (page 7) will be reset.



We highly recommended that a pair of safety beams are installed across the gate entrance and connected to the closing safety beam input on the D2 Turbo if you select Open Only Mode. This will prevent the gate from closing on people, pets or vehicles. (page 11)



PIRAC (Beam Autoclose) (page 9) can be used with Open Only Mode.

- 3.1.2.3. Reversing Mode

Reversing Mode offers slightly more security than Standard Mode as it allows you to close your gate quickly by pressing, for instance, your remote control just as you drive through the gate to prevent children or pets running out - or anybody getting in behind you.

When pressing the button of the remote control or the gate pushbutton on the intercom, your gate will be set in motion. If you press the button again, the gate will move in the opposite direction. So, if the gate is opening and you press the button, the gate will stop and immediately start to close (and vice versa).



Autoclose (page 7) and PIRAC (Beam Autoclose) (page 9) can be used with Reversing Mode.

To configure any of the operating modes please refer to the section, 'Customising the Functions and Settings' on page 24.

3.1.3. Automatic closing (Autoclose Mode)

The D2 Turbo has the facility to automatically close the gate after it has opened (Autoclose Mode). The time that the gate stays open is by default fifteen seconds, but this time period can be set to be five, ten, fifteen, thirty, or forty-five seconds.

As described in the previous section, Autoclose Mode is selectable with Standard Mode (page 5) and Reversing Mode (page 6) - by default the function is Off. However, Autoclose is automatically enabled in Open Only Mode.



CENTURION highly recommends that if you select Autoclose Mode in order to prevent the gate from closing on people, pets or vehicles, a pair of safety beams are installed across the gate entrance and connected to the Closing Safety Beam input on the D2 Turbo.

- 3.1.3.1. Autoclose Override
Autoclose Mode can be overridden in Standard and Reversing Modes by pressing and holding the button of the remote control or intercom gate release for no less than three seconds. The gate response will be to start opening and then to stop as soon as the Autoclose Override feature is activated. On releasing the button, the gate will continue opening until fully open.

Your gate will stay open until you use the remote control or intercom gate release to close the gate. The D2 Turbo will then revert to normal Autoclose operation.



The Autoclose function cannot be overridden in Only Open Mode.

To enable/disable the Autoclose function and/or change the Autoclose time, please refer to the section, 'Customising the Functions and Settings' on page 22.

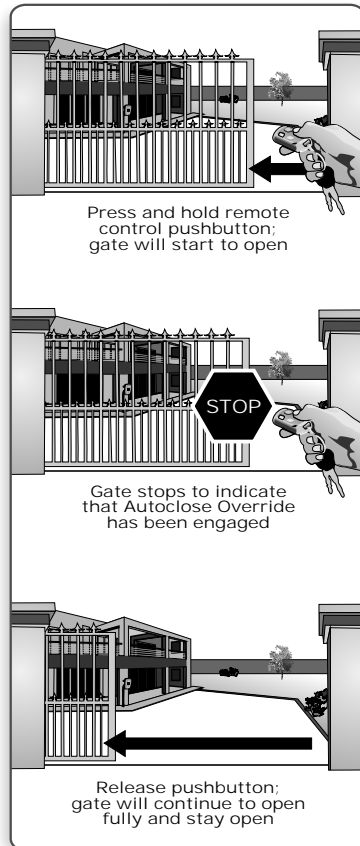

FIGURE 6

3.1.4. Pedestrian Opening

The Pedestrian Opening input opens the gate just wide enough for a pedestrian to pass through the opening.

A second button on your remote control can be used to operate the Pedestrian Opening function. You can also connect a keyswitch or keypad mounted adjacent the gate entrance to operate this function.



FIGURE 7

There is a default two second delay before the gate opens. This is to warn the pedestrian that the gate is about to move.



FIGURE 8

It will also give the person enough time to move their hand away if they are reaching through the gate to operate a keyswitch or a keypad*. If the Courtesy Light* (page 13) is connected to the D2 Turbo's control card, it will flash indicating that the gate will open approximately one metre. The gate will close after a default time of five seconds.

The gate can be kept open by keeping a trigger on the input (keeping your key in the keyswitch, for example) – once removed the gate will close after the fixed five seconds.

If a Closing Safety Beam (page 12) is fitted and the beam is broken while the gate is closing, the gate will stop and open to the Pedestrian Opening position. The gate will remain open while the beam is broken and the five second (fixed) Autoclose Delay will only commence once the beam has been cleared.



* For safety reasons it is recommended that all pedestrian keyswitches and keypads are installed on the opposite end of the gate to where the operator is installed.

3.1.5. PIRAC Mode (Beam Autoclose Mode) - optional



This mode can only be used if a Closing Safety Beam (page 12) is fitted.

This mode can be used in conjunction with any of the Operating Modes - Standard, Open Only and Reversing Modes.

With PIRAC Mode enabled, your gate will close as soon as you have driven through and passed the Safety Beam – giving intruders no time to follow behind you.

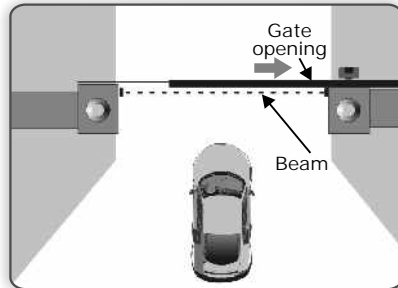

FIGURE 9

If Autoclose Mode is enabled and the gate has been opened but nothing moves through the Closing Safety Beam, the gate will stay fully open for the duration of the Autoclose timer before closing. However, if something passes through the closing beam the gate will close immediately.

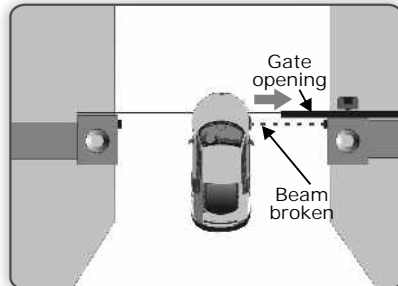

FIGURE 10

If something crosses the beams while the gate is opening, the gate will continue to open until the beam is cleared. Once the beam is cleared, the gate will stop and close. If the gate has reached its fully open position, it will stop and remain open until the beam has been cleared.

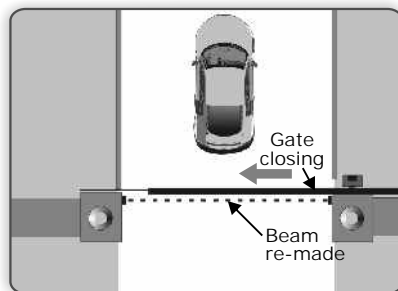

FIGURE 11

To enable/disable PIRAC Mode, please refer to the section, 'Customising the functions and settings' on page 26.

3.1.6. Holiday Lockout Mode

This feature completely immobilises the operator and deactivates all inputs so nobody can get into your property while you are away.

One of the buttons on your remote control can be used to switch the Holiday Lockout function as well as a latching keyswitch or keypad mounted adjacent the gate entrance, accessible from the outside of the property.

When Holiday Lockout is enabled, any of the access control devices that are connected to the D2 Turbo will be rendered inactive. Not even tampering with the keyswitch or keypad on the outside of the property will open the gate – this is particularly useful if you intend leaving your property unattended for extended periods of time.

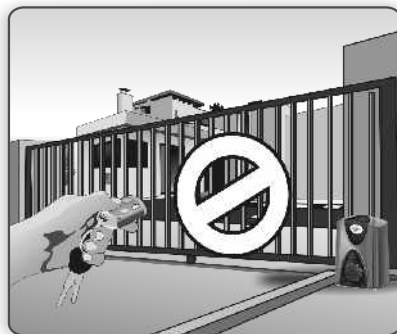

FIGURE 12

If Holiday Lockout is enabled while the gate is moving or in the open position, it will only activate once the gate is back in the closed position.

If somebody tries to open the gate via a valid remote control, keypad code, etc. and Holiday Lockout is enabled, the onboard buzzer will emit one beep periodically for 30 seconds to confirm that the gate has been disabled using this feature.

To enable / disable the Holiday Lockout Mode feature, please refer to the section, 'Customising the functions and settings' on page 19.

3.1.7. Positive Close Mode

Positive Close Mode is intended for applications where the gate must close fully against the gate end post for security reasons – such as ensuring proper contact of a switch on the gate that feeds power to an electric fence.

This feature operates only during the last few millimetres when the gate closes.



It is recommended that a rubber strip be fixed to the front edge of the gate to reduce the noise when the gate closes against the end post.

To enable / disable the Positive Close Mode feature, please refer to the section, 'Customising the functions and settings' on page 28.

3.1.8. Speed Profiles

There's no substitute for speed!

The D2 Turbo can be set to run on either a High Speed Mode (default) which is approximately 24 metres per minute, or a Low Speed Mode which is approximately 16 metres per minute.

High speeds offer a greater level of convenience and security, while slower speeds ensure increased levels of safety at the gate.

To change the Speed Profile, please refer to the section, 'Customising the Functions and Settings' on page 29.

3.1.9. Anti-crushing Sensitivity

The D2 Turbo incorporates a sensitive electronic anti-crushing technology that responds in the events that a person or vehicle obstructs your gate.

Using this technology, the typical response for an opening gate is to immediately stop and retract a short distance, while a closing gate will stop and fully re-open.

Collision Sensing can be set to either High Sensitivity or Low Sensitivity. Generally High Sensitivity should be used, but in instances where the gate runs very poorly Low Sensitivity can be selected.

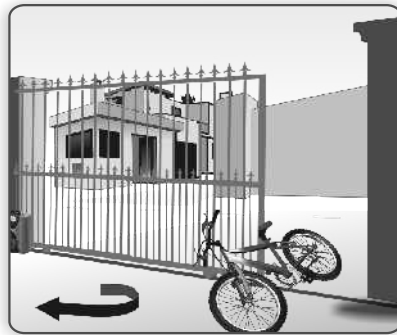

FIGURE 13

- 3.1.9.1. Collision Count

A counter monitors the number of collisions the gate experiences before it fully closes. If the number exceeds the default value of four, the gate will stop. The Status LED (page 14) will flash four times every second until a remote control or intercom gate release pushbutton is pressed.

Please refer to Gate Status Indication (page 14) for more information on this diagnostic device.

To change the Sensitivity setting, please refer to the section, 'Customising the Functions and Settings' on page 30.

3.1.10. Safety Beams (optional, but recommended feature)

It is always recommended to connect additional safety mechanisms to the D2 Turbo instead of relying only on the inherent anti-crushing protection, referred to above.

The typical device is a pair of Infrared Safety Beams which can detect the presence of any vehicle, person or pet that breaks the beam and communicates back to the D2 Turbo that something is in the path of the gate.

Another option is an Inductive Loop Detector, which is mounted in the ground, adjacent to the gate, which is very effective at detecting vehicles or the like, but not persons or pets.

- 3.1.10.1. Closing Safety Beams

Closing Safety Beams provide additional protection against your gate closing on people or vehicles. If the beam is broken while the gate is opening, the gate will continue to open. If the gate is open, the gate cannot be closed if the beam is broken, and if the gate is closing when the beam is broken, it will stop and reopen.

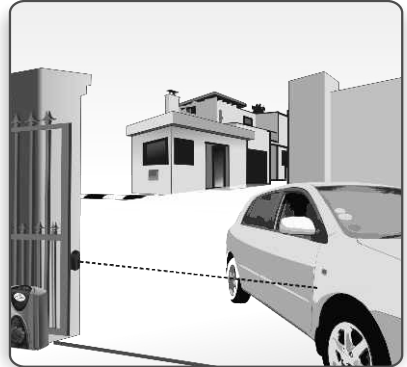

FIGURE 14

If you select the Autoclose (page 7) feature, the gate will remain open if the beam is broken and it will only close after the set Autoclose time has expired when the beam has cleared.

Please contact CENTURION for more information on suitable protection devices.

- 3.1.10.2. Opening Safety Beams

These beams prevent your gate from opening if an object, person or pet is in the way.

If the beam is broken while the gate is closed, the gate will not open. If the gate is opening and the beams are broken, it will stop then close. If the gate is closing while the beams are broken, it will continue to close.



FIGURE 15

3.1.11. Courtesy (Pillar) Light Timer (optional feature)

Courtesy (Pillar) Lights can be connected through the D2 Turbo controller if an adequate* 220V power supply is available at the gate. The lights will switch on every time the gate is given a signal to operate (the trigger could be a remote control button, or the gate pushbutton on an intercom).

The lights will stay on for a fixed period of two minutes, then automatically turn off.

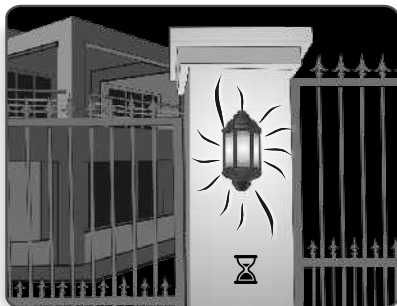

FIGURE 16

The purpose is to bathe your entrance with light when you open the gates and increase your security as you drive into your property – it also saves electricity as the lights only come on when you use the gate motor.

Using the Pedestrian Opening feature will cause the Courtesy (Pillar) Lights to flash three times before the gate opens.

*The cabling that supplies the 220V supply to the D2 Turbo must be suitably sized to carry the additional load of the courtesy (pillar) lights.

- 3.1.11.1. Courtesy (Pillar) Lights act as Warning Light

These modes replace the standard Courtesy Light feature

- 3.1.11.1A. Pre-flashing Modes

Depending on your requirements or local regulations, your gate automation system can provide for two different safety Pre-flashing Modes which will activate the gate's pillar lights if fitted and connected to the D2 Turbo controller.

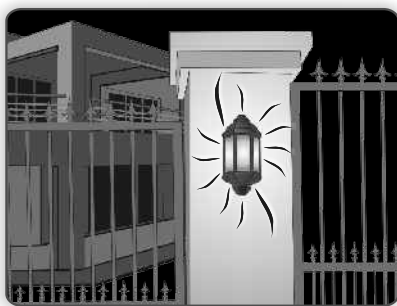

FIGURE 17

- Pre-flashing Mode A

With Pre-flashing Mode A activated, the pillar light relay will only activate during gate movement.

- Pre-flashing Mode C

With Pre-flashing Mode C activated, the pillar light relay will activate for two seconds before gate movement occurs, as well as during gate movement. This means that gate movement will be delayed for

a period of two seconds after a trigger signal has been received.
To change the Courtesy (Pillar) to one of the Pre-flashing Modes, please refer to the section, 'Customising the functions and settings' on page 27.

3.1.12. External Gate Status Indication LED

A LED (Light Emitting Diode) mounted on your intercom allows you to view the position of your gate and the condition of the battery and power supply from the safety of your home. The different signals of the LED are described below:

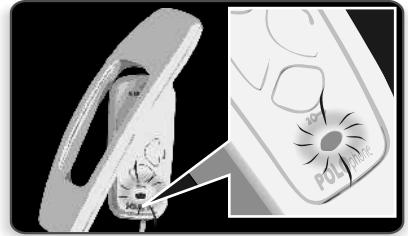

FIGURE 18

Off	Gate is closed
On	Gate is partially or fully open
Continuous slow flash	Gate is opening
Continuous fast flash	Gate is closing
Two flashes every two seconds	No mains present
Three flashes every two seconds	Battery voltage is low
Four flashes every two seconds	Multiple collisions have occurred



If you choose not to fit a Gate Status Indicator, the Status LED on the controller can also be used for trouble-shooting.

3.1.13. Battery Low Protection

The D2 Turbo's controller has circuitry that monitors the state of the battery. During a power failure, energy is drawn from the battery but not replaced.

To protect the battery from being quickly damaged, the protection circuitry prevents the motors from being run off the battery when the battery voltage drops below 10.6 volts.

Indication that the Battery Low Protection has been triggered is provided by the onboard buzzer and status LED on the controller (and intercom if so equipped and connected to the controller). The LED will flash three times every two seconds, as will the buzzer beep three times every two seconds.

The gate system will also shut off until such time as the battery has recharged to an acceptable level.

Consult your gate automation specialist or Centurion Systems if you discover that your Battery Low Protection signal continues to re-occur.

4. Customising the features and functions

"Simplicity is the ultimate sophistication". ~ Leonardo Da Vinci

The D2 Turbo controller makes ordinarily complex settings as quick and easy as possible. Using the Function and Setting Dials, the Select/Toggle Pushbutton , and the bi-colour (red and green) Status LED you can set up the many features and functions in a flash.



FIGURE 15

Please always adjust the Function Dial first.
Set this to the desired function.



FIGURE 16

Then move the Setting Dial to the preferred setting.

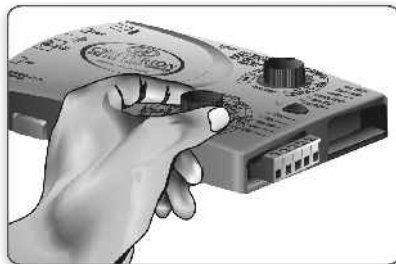

FIGURE 17

Customising the features and functions

If a setting is for a single fixed value, for example, 15 second Autoclose time, then the Select Pushbutton acts as a *select* for that single choice.

However, if the setting has two options, for example On/Off or Hi/Low, then the Pushbutton acts as a *Toggle* between the two preferences.

When using the Select Pushbutton to toggle between preferences the Status LED will light up as green to indicate On or High; or alternatively red to indicate Off or Low.



The Function Dial must always be returned to the Run position (rotated fully counter-clockwise) after you have finished setting up any of the features, modes or profiles. This ensures that it will be ready for use.



FIGURE 18

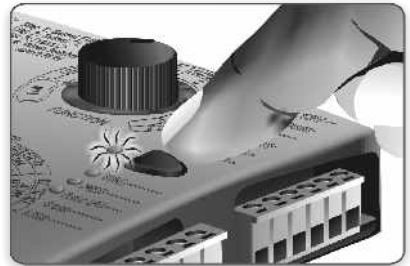

FIGURE 19



FIGURE 20

Examples:

A. Setting up the gate Limits

This is usually performed by an installer at the end of the installation. However, should you need to change these settings, you can do this by simply following these steps:

Step 1: Ensure the gate is in the fully closed position and the motor drive is engaged.

Step 2: Rotate the Function Dial to the LIMITS position (A).

Step 3: Rotate the Setting Dial to the SETUP position along the 'A' row of options.



FIGURE 21

Step 4: Press the Pushbutton to select this feature.



FIGURE 22

The gate will then run through its automated procedure to determine the gate's open and closed positions. If setup is successful, the Status LED will be green, which indicates the setup has finished.



FIGURE 23

Step 5: Return the Function Dial to the RUN position.



FIGURE 24

Customising
the
features
and
functions

B. Remote control administration

The D2 Turbo controller incorporates an onboard multichannel receiver compatible with NOVA secure rolling code (Keeloq™ encryption). The receiver will allow any combination of the different inputs - Trigger (Gate fully open), Pedestrian, Holiday Lockout, etc. to be operated from a single multi-button remote control.

You can also artificially increase the number of buttons by using a two button combination. One of the buttons is used as a shift button to allow the other buttons to be used again in combination with this button. Press and hold the allocated shift button and then press one of the other buttons to create a new button. The shift button cannot be used as a button on its own - it must always be used in combination with another button.

Use of the shift button principle allows a three button transmitter to gain an extra button and operate four functions and a four button transmitter gains two extra buttons and can operate six functions. This is quite handy if you'd like to control additional devices from a single multi-button remote control, for example your garage doors if they are equipped with CENTURION NOVA rolling code receivers (Keeloq™ encryption).

However, it's important to note that the other devices cannot be activated with the new shift button, only the D2 Turbo (and other CENTURION operators that are equipped with an onboard receiver) is able to recognise the shift button signals. Using the shift key principle also prevents you from enabling functions like Holiday Lockout Mode by accident. This is because you have to use both hands to press the two button combination.

At any stage remote controls can be selectively added or deleted within the system. To selectively delete a remote control, the remote control must be available, please refer to the section, 'Deleting specific remote controls' on page 20.



FIGURE 25

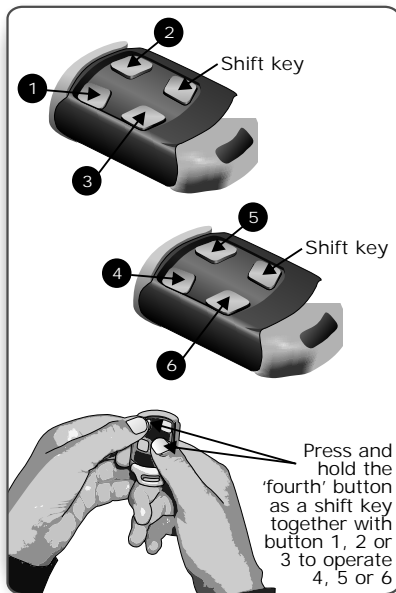

FIGURE 26

C. Adding NOVA remote controls (Keeloq™ encryption)

To add a NOVA rolling code remote control (Keeloq™ encryption) to the onboard receiver and assign a button to any specific function as described above, follow the steps below:

Step 1: Rotate the Function Dial to the REMOTES position (B).

Step 2: Rotate the Setting Dial to the desired selection along the 'B' row of options.



FIGURE 27



You can choose from the following settings:

- Tx TRG to assign a remote control button to be learned into the system and trigger the gate to fully open
- Tx PED to assign a remote control button to be learned into the system and partially open the gate for a pedestrian
- Tx LCK to assign a remote control button to be learned into the system and activate Holiday Lockout Mode

Step 3: Press the Pushbutton to select the setting chosen from above – the Status LED will change from red to green to confirm the setting.



FIGURE 28

Step 4: Press the desired button on the remote control(s) that you want to activate the selected function.

The Status LED will flash twice indicating that the onboard receiver has learned in the remote control(s). The onboard buzzer will also pulse twice.

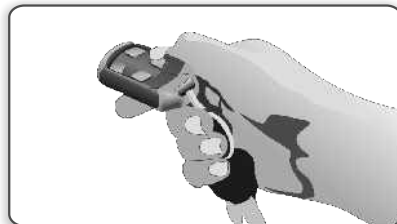

FIGURE 29

Step 5: Return the Function Dial to the RUN position.



FIGURE 30

Customising
the
features
and
functions

D. Deleting specific remote controls

To delete specific remote controls from the D2 Turbo's onboard receiver follow the steps below:

Step 1: Rotate the Function Dial to the REMOTES position (B).

Step 2: Rotate the Setting Dial to DELETE Tx along the 'B' row of options. This will delete specific remote controls from the onboard receiver's memory.



FIGURE 31

Step 3: Press the Pushbutton to select - the Status LED will change from red.

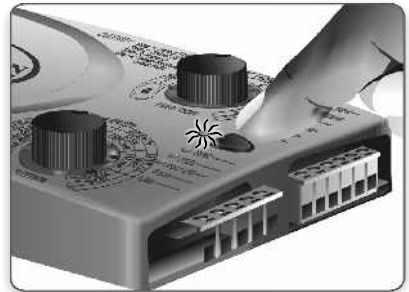

FIGURE 32

Step 4: Press any button on the specific remote control(s) that you want to delete from the onboard receiver's memory. The Status LED will flash green three times and the buzzer will also beep three times, indicating that the onboard receiver has deleted the remote control(s) from its memory.

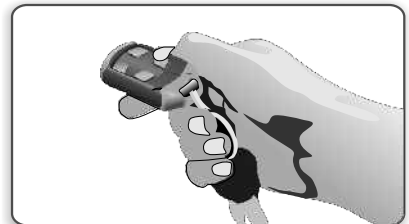

FIGURE 33

Step 5: Return the Function Dial to the RUN position.



FIGURE 34

E. Deleting ALL remote controls

To delete all the learned-in remote controls from the D2 Turbo's onboard receiver follow the steps below:

Step 1: Rotate the Function Dial to the REMOTES position (B).

Step 2: Rotate the Setting Dial to the DELETE ALL position along the 'B' row of options. This will delete all remote controls from the onboard receiver's memory.



FIGURE 35

Step 3: Press the pushbutton to select the setting.

The Status LED will initially flash red. Hold down the pushbutton until the Status LED turns green and three beeps are heard. This will indicate that the onboard receiver has deleted the remote control(s) from its memory.



FIGURE 36

Step 4: Return the Function Dial to the RUN position.



FIGURE 37

Customising
the
features
and
functions

F. Setting the Autoclose feature

The Autoclose feature can be selected to be either Off or Activated, with a pre-selected time delay.

F1. Activating the Autoclose feature:

To activate the Autoclose feature with as pre-selected time delay, follow the steps below:

Step 1: Rotate the Function Dial to the AUTOCLOSE position (C).

Step 2: Rotate the Setting Dial to the desired time delay setting along the 'C' row of options. You can choose either 5 seconds, 10 seconds, 15 seconds, 30 seconds or 45 seconds.



FIGURE 38

Step 3: Press the Pushbutton to select your choice.



FIGURE 39

The Status LED will change from red to green indicating that the Autoclose feature has been activated with the delayed time selected in Step 2.



FIGURE 40

Step 4: Return the Function Dial to the RUN position.

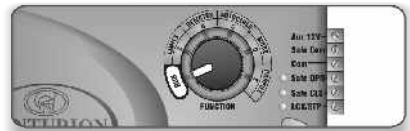

FIGURE 41



Please note that if the operator is running in Open Only Mode – the Autoclose feature is activated with a 15 second delay as the default – this can be changed if necessary.

F2. De-activating the Autoclose feature

To de-activate the Autoclose feature, follow the steps below:

Step 1: Rotate the Function Dial to the AUTOCLOSE position (C).

Step 2: Rotate the Setting Dial to the OFF selection along the 'C' row of options.

The Status LED will be red if Autoclose is on. If it is already Off, the Status LED will be green.



FIGURE 41

Step 3: Press the Pushbutton to select.

The Status LED will change from red to green indicating that the Autoclose feature has been deactivated or switched Off.

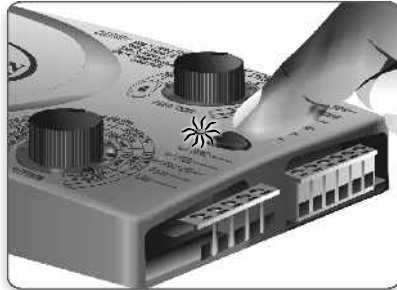

FIGURE 42

Step 4: Return the Function Dial to the RUN position.



FIGURE 43



Please note that if the operator is running in Open Only Mode – the Autoclose feature cannot be de-activated.

G. Setting the Mode of Operation

The D2 Turbo has three modes to choose from depending on the application. Only one mode can be selected at any given time.

G1. Standard Mode:

Step 1: Rotate the Function Dial to the MODE position (D).

Step 2: Rotate the Setting Dial to the STD selection along the 'D' row of options.



FIGURE 44

Step 3: Press the Pushbutton to select the setting.

The Status LED will change from red to green indicating that the Standard Operating Mode has been activated.



FIGURE 45

Step 4: Return the Function Dial to the RUN position.

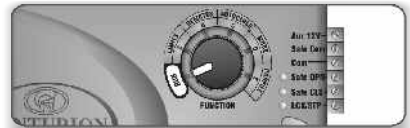

FIGURE 46



PIRAC Mode can be active while in Standard Mode, if desired.

G2. Open Only Mode:

Step 1: Rotate the Function Dial to the MODE position (D).

Step 2: Rotate the Setting Dial to the OPEN ONLY selection along the 'D' row of options.



FIGURE 47

Step 3: Press the pushbutton to select the setting.

The Status LED will change from red to green indicating that the Open Only Mode has been activated.



FIGURE 48

Step 4: Return the Function Dial to the RUN position.



FIGURE 49



PIRAC Mode can be active while in Standard Mode, if desired.

G3. Reversing Mode:

Step 1: Rotate the Function Dial to the MODE position (D).

Step 2: Rotate the Setting Dial to the REVERSING selection along the 'D' row of options.



FIGURE 50

Step 3: Press the Pushbutton to select the setting.

The Status LED will change from red to green indicating that the Reversing Mode has been activated.



FIGURE 51

Step 4: Return the Function Dial to the RUN position.



FIGURE 52



PIRAC Mode can be active while in Standard Mode, if desired.

H. Setting PIRAC Mode

PIRAC (Beam Autoclose) Mode can be activated when using any of the three Operating Modes (Standard, Open Only, or Reversing).

To select PIRAC Mode as either On or Off, please follow the following steps:

Step 1: Rotate the Function Dial to the MODE position (D).

Step 2: Rotate the Setting Dial to the PIRAC on/off selection along the 'D' row of options.



FIGURE 53

Step 3: Press the Pushbutton to toggle between On and Off.

The Status LED will change from red to green indicating that PIRAC has been activated, or it will change to red indicating that PIRAC Mode has been deactivated.

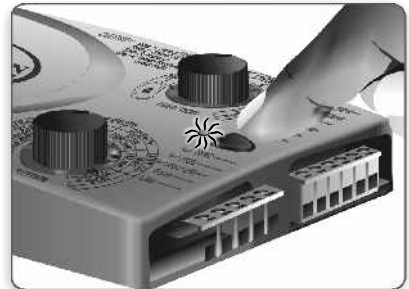

FIGURE 54

Step 4: Return the Function Dial to the RUN position.

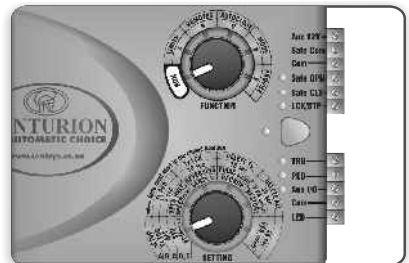

FIGURE 55

I. Setting the Pre-flashing Modes

Pre-flashing Mode A and Pre-flashing Mode C can be activated in addition to any of the above modes of operation.

To select a Pre-flash Mode as either on or off please follow these steps:

Step 1: Rotate the Function Dial to the MODE position (D).

Step 2: Rotate the Setting Dial to either PFA on/off for Pre-flash Mode A, or PFC on/off for Pre-flash Mode B along the 'D' row of options.



FIGURE 56

Step 3: Press the Pushbutton to toggle the Pre-flash Mode between On and Off.

The Status LED will change from red to green indicating that the selected Pre-flashing Mode has been activated, or it will change to red indicating that it has been de-activated.

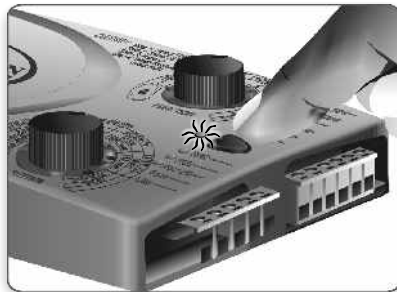

FIGURE 57

Step 4: Return the Function Dial to the RUN position.



FIGURE 58

Customising the features and functions

J. Setting the Operating Profiles

Three Operating Profiles, Positive Close Mode, Speed and Collision Sensitivity, can each be configured depending on your individual requirements.

J1. Positive Close Mode

Step 1: Rotate the Function Dial to the PROFILE position (E).

Step 2: Rotate the Setting Dial to PCM on/off along the 'E' row of options.



FIGURE 59

Step 3: Press the pushbutton to toggle the chosen mode between On and Off.

The Status LED will change from red to green indicating that the selected Positive Close Mode has been activated, or it will change to red indicating that it has been de-activated.

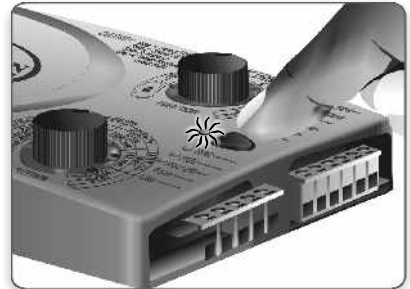

FIGURE 60

Step 4: Return the Function Dial to the RUN position.



FIGURE 61

J2. Setting the Speed Profile to High or Low

To select the desired speed profile, either High (approximately 24m/min) or Low (approximately 16m/min) please follow these steps:

Step 1: Rotate the Function Dial to the PROFILE position (E).

Step 2: Rotate the Setting Dial to SPEED hi/lo along the 'E' row of options.



FIGURE 62

Step 3: Press the Pushbutton to toggle Speed profile between High and Low.

The Status LED will change from red to green indicating that the High Speed Profile has been activated, or it will change to red indicating that the Low Speed Profile has been activated.



FIGURE 63

Step 4: Return the Function Dial to the RUN position.



FIGURE 64

Customising
the
features
and
functions

J3. Setting the Anti-crushing Sensitivity Profile

To select the desired sensitivity of the anti-crushing technology to either High or Low please follow the following steps:

Step 1: Rotate the Function Dial to the PROFILE position (E).

Step 2: Rotate the Setting Dial to SENS hi/lo along the 'E' row of options.



FIGURE 65

Step 3: Press the pushbutton to toggle the Sensitivity Profile between High and Low.

The Status LED will change from red to green indicating that the High Sensitivity Profile has been activated, or it will change to red indicating that the Low Sensitivity Profile has been activated.

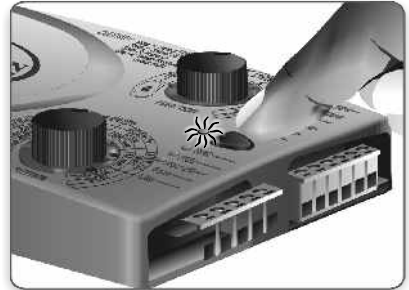

FIGURE 66

Step 4: Return the Function Dial to the RUN position.

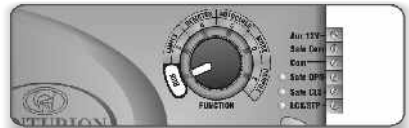

FIGURE 67

K. Verifying your setup

Should you wish to verify your settings you can rotate the Function Dial to the function that you want to check the settings of. Then rotate the Setting Dial to the various selection options. The status LED will light up as green to indicate that the selected option is either On or High; or alternatively red to indicate Off or Low.

5. Additional features

5.1. Battery saver

In the event of a battery low shutdown, only the motor will stop drawing current – the controller, infrared beams and any other peripheral device will continue to flatten the battery, however, at a much slower rate.

An optional low cut-out switch (product code CP107) totally disconnects the battery and protects it from being fully discharged and potentially damaged.

Consult your gate automation specialist or Centurion Systems for further details.



FIGURE 68

5.2. Solar power supply

A solar panel can be used to charge the battery instead of the conventional charging circuit. A 20 Watt panel will provide enough power for 20 daily operations (less if 12V DC security lights are fitted) of an average gate.

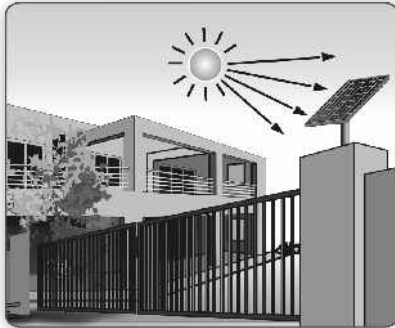

FIGURE 69

Additional features

6. Basic maintenance

CENTURION operators are designed to be maintenance-free. However, there are some basic checks that should be carried out regularly, (every six months). These checks will increase the long term reliability of the system and prevent erratic operation of your gate.



WARNING! Isolate mains supply to system before cleaning or working on the equipment.

General

- Keep the track clear of stones, dirt and obstructions
- Ensure that all rollers run freely
- Put the operator into Manual Mode and check that the gate runs freely on its rail and does not catch or foul against the walls or pillars
- Ensure that the gate wheels and guide-rollers are rotating freely and are not worn. In high-volume applications it will be necessary to replace these components regularly
- Ensure that the rack is properly secured to the gate and that it does not press down onto the operator pinion at any point along its travel
- Keep shrubs and vegetation clear of the motor and rack
- Check that the key still operates the camlock - spray with lubrication if necessary
- Keep the inside of the motor housing clear of insects and dust

Battery

CENTURION operators are fitted with high quality, maintenance-free lead acid batteries which should provide up to three years of normal service life.

- Check for corrosion of the battery terminals.
- Clean and apply copper-based grease as necessary.

7. Servicing your D2 Turbo

Refer all servicing to qualified service personnel. Consult Centurion Systems for assistance.

Your D2 Turbo sliding gate operator requires no special care other than that described in the Maintenance section.

If you are having a problem with your D2 Turbo sliding gate operator, please contact your installer or Centurion Systems.

8. Diagnostics

Depending on the type of fault or condition of the motor, audible feedback will be given via the onboard buzzer. Listen out for this and refer to the table below:

The different conditions are given in order of precedence.

Battery Low – Buzzer will emit three beeps every two seconds for 30 seconds. Refer to section, 'Battery Low'

Multiple Collisions – Buzzer will beep periodically until condition is cleared. Refer to section, 'Anti-crushing, collision count'

Holiday Lockout Mode – If Holiday Lockout Mode has been enabled, when triggering to operate the gate, the gate will not operate but the buzzer will emit one beep periodically for 30 seconds

Mains Failure – If the mains supply to the charger has failed the buzzer will emit two beeps every two seconds for 30 seconds

Safety Beams Broken – if something in the path of the beams the buzzer will emit one beep periodically for 30 seconds

Safety Beams Failure – if the safety beams are not operating the buzzer will emit three beeps each time the gate is triggered

Contact your gate automation specialist or Centurion Systems for further assistance.



WARNING! Do not attempt to repair the unit yourself. Any work performed by unauthorised personnel may void the warranty.

9. Specifications

Technical specifications

Input voltage	220V AC \pm 10%, 50Hz
Motor voltage	12V DC
Motor power supply	Battery driven (standard capacity - 12V 5Ah)
Battery charger	1A @ 13.7V
Current consumption (mains)	70mA
Current consumption (motor at rated load)	8A
Operator push force - starting	18kgf
Operator push force - rated	9kgf
Gate mass – maximum	250kg
Gate length - maximum	20m
Gate speed (varies with load)	24m/min
Manual Override	Lockable with key release
Maximum numbers of operations per day	10 (Based on 10 year life expectancy)
Collision sensing	Electronic
Operating temperature range	-15°C to +50°C
Onboard receiver type	NOVA rolling code (Keeloq™ encryption), multichannel output
Receiver code storage capacity	32 transmitter buttons
Receiver frequency	433MHz

10. 24 Month product warranty



You can register your product(s) online at www.centsys.co.za which will assist you in keeping a record of your date of purchase or installation, serial numbers, etc.

This information may come in handy for future reference to help you in the event of a warranty claim, or to remember your installer's details, or for any other future reference needs that may arise.

All CENTURION products are manufactured with extreme care, thoroughly inspected and tested. All CENTURION products are warranted against faulty materials and workmanship for a period of 24 months from the invoice date of the product or 26 months from the manufacturing date (as shown on the serial number label of the operator), whichever expires first.

The warranty will cover the repair or replacement, at the discretion of Centurion Systems, of such faulty materials or parts free of charge provided that the equipment is returned to our workshop. The workmanship of the installation of the products carried out by any third party is specifically not covered under this warranty (please consult with your installer about their workmanship warranty terms and conditions). For equipment not of CENTURION's manufacture the warranty as supplied by the original manufacturer will apply.

No claims whatsoever will be recognised under the terms of this warranty which pertain to damage, injury, cost or expense, suffered by persons and / or to property, which either directly or indirectly arise out of any one of the following occurrences:

- a) Failure to install the product in accordance with the installation instructions provided by Centurion Systems.
- b) Failure to abide by the safety instructions provided by Centurion Systems.

This warranty will not apply to any equipment which:

- a) Has not been installed in accordance with the installation instructions provided.
- b) Has been subject to misuse or which has been used for any purpose other than that designed for by the manufacturers.
- c) Has damage caused as a result of handling during transit, atmospheric conditions (including lightning), insect infestation, power surges or other forces outside of the control of Centurion Systems.
- d) Has been repaired by any workshop and / or person NOT previously authorised by Centurion Systems.
- e) Has been repaired with components not previously tested, passed or authorised by Centurion Systems.

24 Month
product
warranty

D2 Turbo 24 Month Warranty Sticker

For your own record and reference purposes if claiming against the warranty - Stick Barcode product and serial number label for the operator here.

24 Month
product
warranty

11. Optional extras

i5 Infrared Safety Beams

Always recommended on any gate automation installation

SmartGUARD keypad

Cost-effective and versatile keypad, allowing for access to pedestrians, armed response companies, etc

SOLO/Lattice Proximity Access Control System

Proximity reader, allowing for access to both pedestrians and vehicles, while offering a higher level of security than a keypad

Pedestrian keyswitch

Allows for pedestrians to partially open the gate using a key

POLOphone Intercom System

Allow visitors to communicate with residents in order to gain access to the property

POLOview Surveillance System

Enhances the POLOphone to provide CCTV at the gate

Theft-resistant Cage

Retro-installable steel cage that increases the resistance of the operator against theft

Theft-resistant Locking Nut with Discus Padlock

Retro-installable theft-resistant locking nut and padlock set



FIGURE 70

Notes

Notes

Lined area for writing notes, consisting of horizontal dotted lines.



Notes



A series of horizontal dotted lines for writing notes.





Sharecall number **0860-CENTURION**
(Please note that this number is only applicable if dialed from within South Africa)

Please visit **www.centsys.co.za**
for more information on the world-class products manufactured by
Centurion Systems, as well as for details of your nearest agent

Manufactured by:

Centurion Systems (Pty) Ltd Head Office

Tel +27(0)11 699 2400 Fax +27(0)11 704 3412
or (0)11 462 6669

Unit 13 Northlands Production Park
Intersection Epsom Avenue and Newmarket Road
Northriding JOHANNESBURG 2196

PO Box 506 Cramerview 2060 South Africa

www.centsys.co.za
sales@centsys.co.za
info@centsys.co.za

(Please omit the (0) when dialing from outside South Africa)

South African Branches and Regional
Distributors

Bloemfontein	(0)51 430 0870
Cape Town	(0)21 510 0951
Durban	(0)31 701 9583
East London	(0)43 743 4923
Johannesburg Central/West Rand	(0)11 699 2400
Johannesburg East Rand	(0)11 397 6401
Kimberly	(0)53 832 3231
Nelspruit	(0)13 752 8074/5
Port Elizabeth	(0)41 367 1292
Pretoria	(0)12 349 1745
Vereeniging	(0)16 422 5667



DR: 1195.D.01.0003_1 D2 Turbo User Guide RD: 18.02.2011 MAP: 0000.D.01.0008_3

